

Material : Thimble: Mild steel
Link: Alloy steel
Finish : Painted
Temperature range : -4°F up to +392°F
Standard certification : Certificate of Conformity

Suitable for fibre rope
Special link or thimble on request

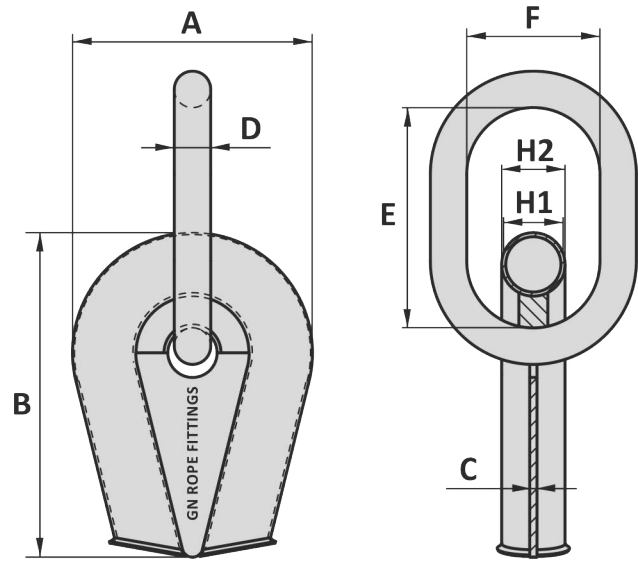
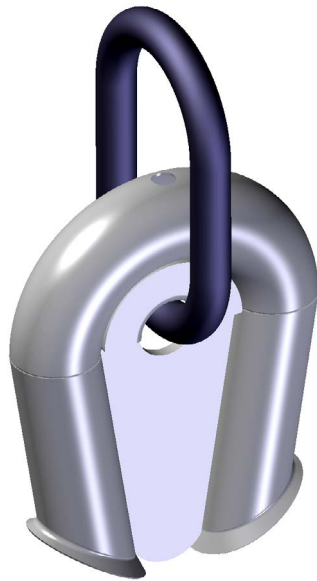

Art. No.	Rope size inch	MBL link ton	A inch	B inch	C inch	H1 inch	H2 inch	D inch	E inch	F inch	Weight lbs
18000632	6	40	10	12 3/16	2 5/32	2 1/2	2 3/4	1 1/4	7 7/8	4 5/16	26
18000636	6	64	10	12 3/16	2 5/32	2 1/2	2 3/4	1 1 3/32	10 1/4	5 1/2	31
18000645	6	104	10	12 3/16	2 5/32	2 1/2	2 3/4	1 2 5/32	13 3/8	7 3/32	46
18000836	8	64	12 1/2	16 1/8	1 3/16	3 7/32	3 1/2	1 1 3/32	10 1/4	5 1/2	49
18000845	8	104	12 1/2	16 1/8	1 3/16	3 7/32	3 1/2	1 2 5/32	13 3/8	7 3/32	64
18000851	8	144	12 1/2	16 1/8	1 3/16	3 7/32	3 1/2	2	13 2 5/32	7 1 5/32	73
18001045	10	104	16 1/2	22 7/16	2 5/32	4 7/32	4 1/2	1 2 5/32	13 3/8	7 3/32	90
18001051	10	144	16 1/2	22 7/16	2 5/32	4 7/32	4 1/2	2	13 2 5/32	7 1 5/32	99
18001057	10	188	16 1/2	22 7/16	2 5/32	4 7/32	4 1/2	2 1/4	15 3/4	7 7/8	115
18001263	12	232	20 1/2	26 2 5/32	2 5/32	5 3/16	5 1/2	2 1 5/32	16 1 5/16	9 1/16	152
18001272	12	336	20 1/2	26 2 5/32	2 5/32	5 3/16	5 1/2	2 2 5/32	17 5/16	9 2 5/32	181
18001280	12	420	20 1/2	26 2 5/32	2 5/32	5 3/16	5 1/2	3 3/32	17 2 3/32	9 2 7/32	205
18001572	15	336	24 3/8	32 3/8	1	6 1/4	6 5/8	2 2 7/32	17 5/16	9 2 7/32	262
18001580	15	420	24 3/8	32 3/8	1	6 1/4	6 5/8	3 3/32	17 2 3/32	9 2 7/32	287
18001590	15	524	24 3/8	32 3/8	1	6 1/4	6 5/8	3 1/16	18 1/8	11 1 3/16	333
18001880	18	420	28 2 5/32	38 1/2	1 3/16	7 3/16	7 5/8	3 5/32	17 2 3/32	9 2 7/32	401
18001890	18	524	28 2 5/32	38 1/2	1 3/16	7 3/16	7 5/8	3 1/16	18 1/8	11 1 3/16	448
18001810	18	628	28 2 5/32	38 1/2	1 3/16	7 3/16	7 5/8	3 1 5/16	19 1 1/16	11 1 3/16	500
18002190	21	524	32 5/8	45 1 5/32	1 3/16	8 5/32	8 5/8	3 1/16	18 1/8	11 1 3/16	558
18002110	21	628	32 5/8	45 1 5/32	1 3/16	8 5/32	8 5/8	3 1 5/16	19 1 1/16	11 1 3/16	611
18002112	21	1000	32 5/8	45 1 5/32	1 3/16	8 5/32	8 5/8	4 1 5/32	23 5/8	15 3/4	747
18002410	24	628	36 3/8	52 1 5/16	1 1/16	9 1/8	9 2 5/32	3 1/16	19 1 1/16	11 1 3/16	822
18002412	24	1000	36 3/8	52 1 5/16	1 1/16	9 1/8	9 2 5/32	4 1 5/32	23 5/8	15 3/4	959

Tolerance: ± 5%, machined parts ± 1/32 inch

30-05-2016

GENERAL SHACKLES THIMBLES SOCKETS LINKS SWIVELS HOOKS MOORING OTHERS

Material : Thimble: Mild steel
Link: Alloy steel
Finish : Painted
Temperature range : -20°C up to +200°C
Standard certification : Certificate of Conformity

Suitable for fibre rope
Special link or thimble on request

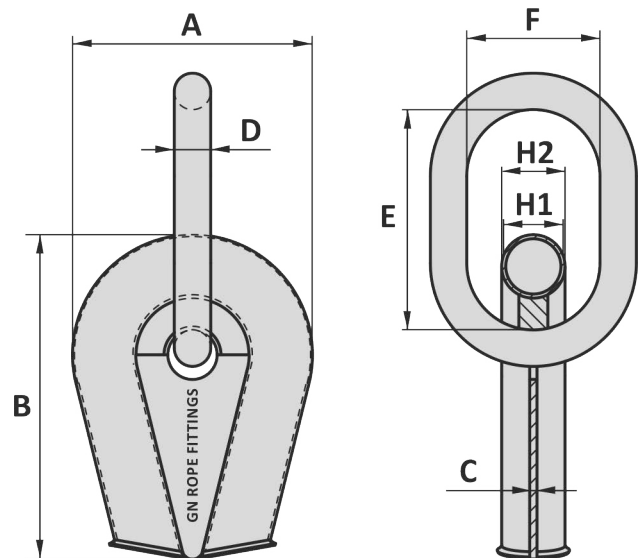
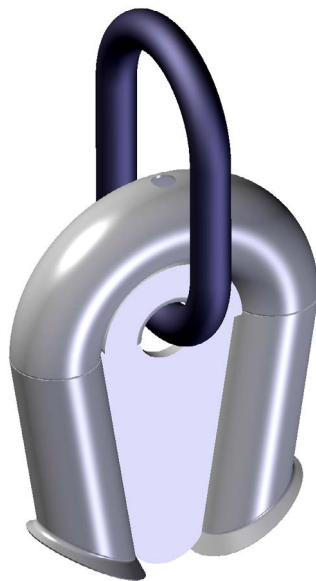

Art. No.	Rope size inch	MBL link ton	A mm	B mm	C mm	H1 mm	H2 mm	D mm	E mm	F mm	Weight kg
18000632	6	40	254	310	20	64	70	32	200	110	12
18000636	6	64	254	310	20	64	70	36	260	140	14
18000645	6	104	254	310	20	64	70	45	340	180	21
18000836	8	64	318	410	30	82	89	36	260	140	22
18000845	8	104	318	410	30	82	89	45	340	180	29
18000851	8	144	318	410	30	82	89	51	350	190	33
18001045	10	104	419	570	20	107	114	45	340	180	41
18001051	10	144	419	570	20	107	114	51	350	190	45
18001057	10	188	419	570	20	107	114	57	400	200	52
18001263	12	232	521	680	20	132	140	63	430	230	69
18001272	12	336	521	680	20	132	140	72	440	250	82
18001280	12	420	521	680	20	132	140	80	450	250	93
18001572	15	336	625	822	25	159	168	72	440	250	119
18001580	15	420	625	822	25	159	168	80	450	250	130
18001590	15	524	625	822	25	159	168	90	460	300	151
18001880	18	420	734	978	30	183	194	80	450	250	182
18001890	18	524	734	978	30	183	194	90	460	300	203
18001810	18	628	734	978	30	183	194	100	500	300	227
18002190	21	524	829	1155	30	207	219	90	460	300	253
18002110	21	628	829	1155	30	207	219	100	500	300	277
18002112	21	1000	829	1155	30	207	219	115	600	400	339
18002410	24	628	924	1345	40	232	245	100	500	300	373
18002412	24	1000	924	1345	40	232	245	115	600	400	435

Tolerance: ± 5%, machined parts ± 1 mm

30-05-2016