

Material : Alloy steel
 Safety factor : 4 times
 Finish : Painted
 Temperature range : -40°F up to +392°F, Polar Rated
 Standard certification : Certificate of Conformity
 3.1 material certificate EN 10204

Spare latches available on request

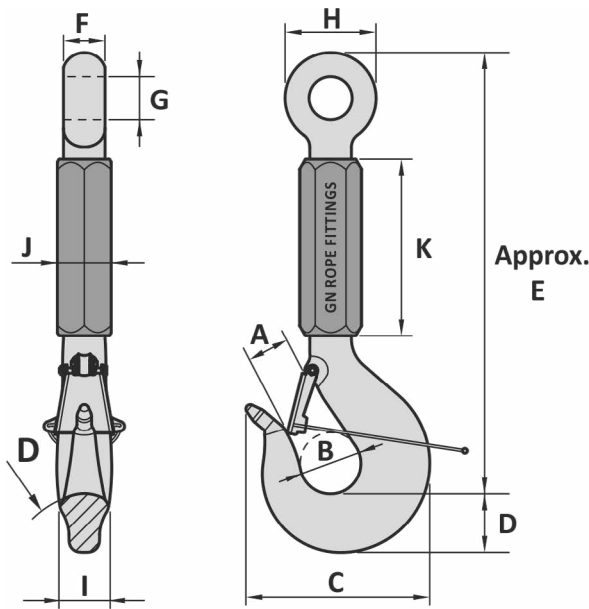

Type for hook WLL 5.4 ton ≤ WLL 80 ton

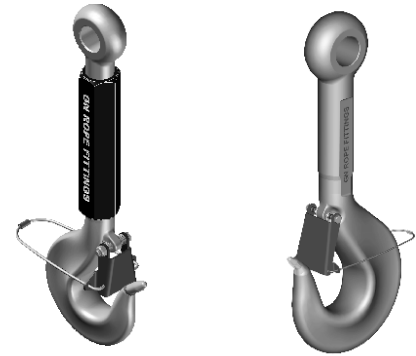
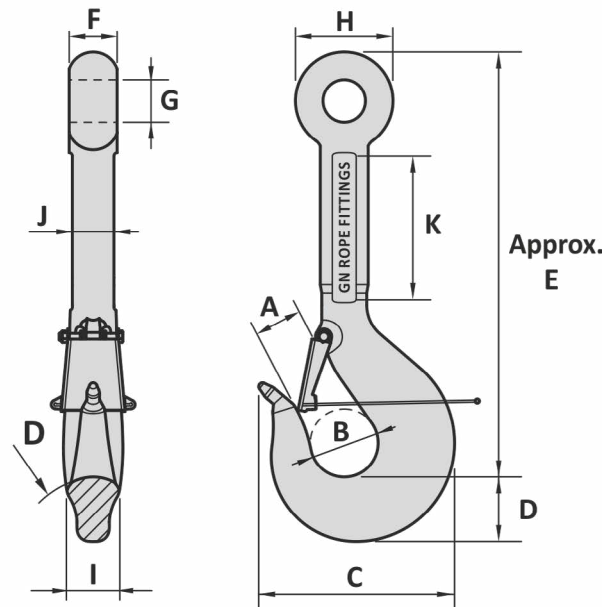

Type for hook WLL 100 ton ≤ WLL 400 ton

Art. No.	WLL ton	MBL ton	A inch	B inch	C inch	D inch	E inch	F inch	G inch	H inch	I inch	J inch	K inch	Weight lbs
53000005	5.4	21.6	1 11/32	1 31/32	6 11/32	1 9/16	20 9/32	1 11/32	1 7/32	2 11/16	1 1/4	1 25/32	9 27/32	12
53000012	12.5	50	1 5/8	2 15/32	7 7/8	2 9/32	22 1/4	1 25/32	1 9/16	3 9/16	1 25/32	2 3/8	10 1/4	26
53000016	16	64	1 15/16	2 3/4	8 13/16	2 5/8	24	1 7/8	1 3/4	4	2 3/32	2 3/8	11 1/32	37
53000025	25	100	2 5/32	3 5/32	9 3/4	2 15/16	25 15/32	2 3/16	2 1/16	4 7/8	2 3/8	2 3/4	10 5/8	49
53000032	32	128	2 7/16	3 9/16	11 11/32	3 1/32	31 1/2	2 9/16	2 3/8	5 5/8	2 5/8	3 5/32	12 3/16	77
53000040	40	160	2 23/32	3 15/16	12 7/16	3 3/4	32 5/32	2 3/4	2 3/4	5 29/32	2 15/16	3 1/32	13	104
53000050	50	200	3	4 13/32	13 1/2	4 3/16	33 15/32	3 5/32	3 1/16	6 5/8	3 11/32	3 15/16	13 25/32	137
53000063	63	252	3 7/16	4 15/16	14 13/16	4 21/32	39 5/8	3 11/32	3 3/8	7 3/32	3 3/4	4 5/16	14 3/16	194
53000080	80	320	3 13/16	5 1/2	16 7/16	5 5/16	37 19/32	3 15/16	3 3/8	8 1/4	4 3/16	4 23/32	11 13/32	245
53000100	100	400	4 7/16	6 5/16	18 3/16	5 29/32	39 5/8	4 5/16	3 15/16	8 31/32	4 21/32	3 7/8	12 19/32	342
53000125	125	500	5 7/16	7 3/32	20 1/32	6 11/16	41 11/32	4 7/8	4 5/16	10 1/4	5 3/16	4 3/16	11 1/32	461
53000160	160	640	5 3/8	7 7/8	23	7 15/32	43 5/16	5 7/16	5 1/8	11 13/16	5 29/32	4 23/32	11 1/32	699
53000200	200	800	6 9/16	8 13/16	25 1/2	8 11/32	47 1/4	6 5/16	5 1/8	13 25/32	6 11/16	5 11/32	11 1/32	809
53000250	250	1000	7 13/32	9 27/32	29 5/8	9 9/32	49 5/32	7 3/32	5 23/32	14 9/16	7 15/32	5 29/32	11 13/16	1360
53000300	300	1200	8 7/16	11 1/32	32 15/32	10 7/16	51 3/32	7 15/32	6 3/16	15 15/16	8 11/32	6 5/16	11 13/16	1609
53000400	400	1600	8 7/8	12 13/32	36 5/32	11 13/16	55 5/8	8 1/4	7 5/32	18 5/16	9 9/32	7 3/32	11 13/16	2205

Tolerance: Forged parts ± 5%, machined parts ± 1/32 inch

18-12-2017

Material : Alloy steel
 Safety factor : 4 times
 Finish : Painted
 Temperature range : -40°C up to +200°C, Polar Rated
 Standard certification : Certificate of Conformity
 3.1 material certificate EN 10204

Spare latches available on request

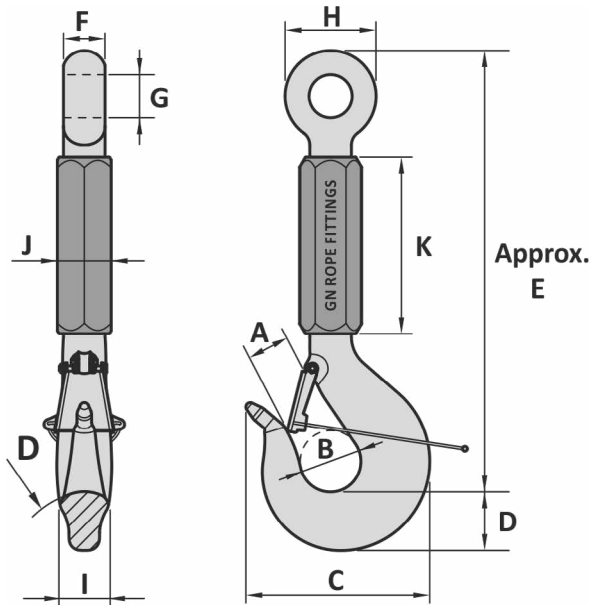
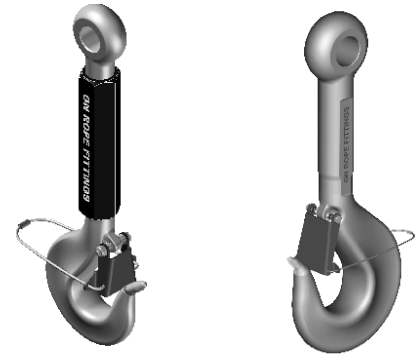

Type for hook WLL 5.4 ton ≤ WLL 80 ton

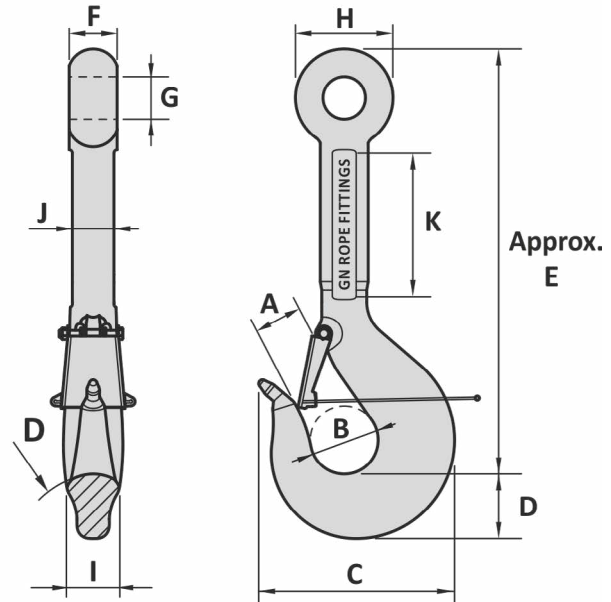

Type for hook WLL 100 ton ≤ WLL 400 ton

Art. No.	WLL ton	MBL ton	A mm	B mm	C mm	D mm	E mm	F mm	G mm	H mm	I mm	J mm	K mm	Weight kg
53000005	5.4	21.6	34	50	161	40	515	34	31	68	32	45	250	5.3
53000012	12.5	50	41	63	200	58	565	45	40	90	45	60	260	12
53000016	16	64	49	70	224	67	610	48	44	102	53	60	280	17
53000025	25	100	55	80	248	75	650	56	52	105	60	70	270	22
53000032	32	128	59	90	288	85	800	65	60	130	67	80	310	35
53000040	40	160	69	100	316	95	820	70	70	150	75	85	330	47
53000050	50	200	76	112	343	106	850	80	78	162	85	100	350	62
53000063	63	252	84	125	376	118	1000	85	86	180	95	110	360	92
53000080	80	320	97	140	418	132	950	100	86	210	106	120	290	111
53000100	100	400	110	160	462	150	1000	110	100	228	118	98	320	155
53000125	125	500	132	180	509	170	1050	124	110	260	132	106	280	209
53000160	160	640	137	200	584	190	1100	138	130	300	150	120	280	317
53000200	200	800	167	224	648	212	1200	160	130	350	170	136	280	367
53000250	250	1000	188	250	740	236	1250	180	145	370	190	150	300	617
53000300	300	1200	205	280	825	265	1320	190	160	405	212	160	300	730
53000400	400	1600	225	315	920	300	1400	210	185	465	236	180	300	1000

Tolerance: Forged parts ± 5%, machined parts ± 1 mm

18-12-2017