

Material : Alloy steel
 Safety factor : 4 times
 Finish : Painted
 Temperature range : -40°C up to +200°C, Polar Rated
 Standard certification : Certificate of Conformity
 3.1 material certificated EN 10204

Non-standard sizes or custom products available on request

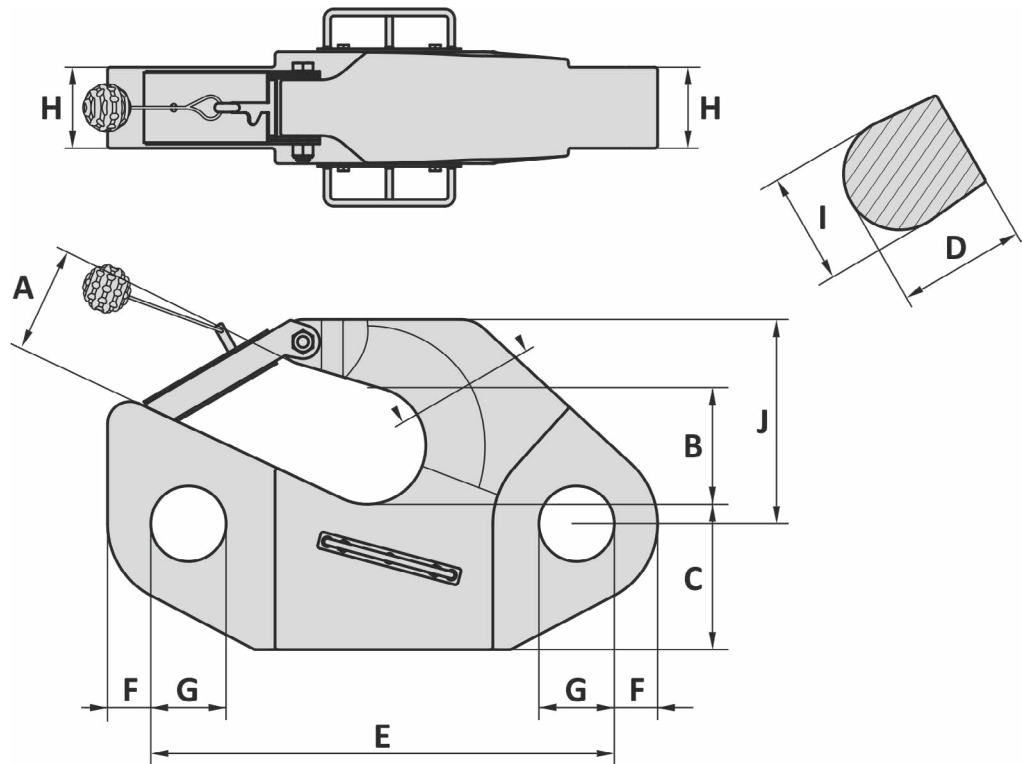
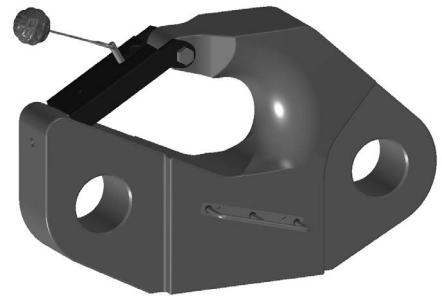

Art. No.	WLL ton	MBL ton	A mm	B mm	C mm	D mm	E mm	F mm	G mm	H mm	I mm	J mm	Weight kg
77000100	100	400	147	160	190	160	630	65	110	100	140	280	185
77000150	150	600	165	180	230	200	720	70	120	120	180	335	299
77000200	200	800	185	210	260	220	830	78	135	145	200	365	467
77000250	250	1000	219	250	290	240	920	90	150	170	230	425	683
77000300	300	1200	266	300	320	270	1055	100	160	180	260	475	955
77000400	400	1600	285	320	350	300	1125	105	180	200	300	505	1231
77000500	500	2000	302	340	390	320	1215	110	190	220	320	550	1573
77000600	600	2400	313	350	420	350	1285	120	210	250	340	580	1936
77000700	700	2800	323	360	450	370	1325	125	220	280	380	600	2334
77000800	800	3200	337	380	500	400	1480	140	240	300	400	665	3120

Tolerance: Machined parts ± 1 mm

Art. No.	WLL ton	MBL ton	A inch	B inch	C inch	D inch	E inch	F inch	G inch	H inch	I inch	J inch	Weight lbs
77000100	100	400	5 25/32	6 5/16	7 15/32	6 11/16	24 13/16	2 5/16	4 5/16	3 15/16	5 1/2	11 1/2	408
77000150	150	600	6 1/2	7 3/32	9 1/16	7 7/8	28 11/32	2 3/4	4 23/32	4 23/32	7 3/32	13 3/16	659
77000200	200	800	7 7/32	8 1/4	10 1/4	9 1/16	32 11/16	3 1/16	5 5/16	5 23/32	7 7/8	14 3/8	1030
77000250	250	1000	8 5/8	9 27/32	11 13/32	9 7/16	36 7/32	3 3/16	5 29/32	6 11/16	9 1/16	16 3/4	1506
77000300	300	1200	10 15/32	11 13/16	12 19/32	11 1/32	41 1/32	3 15/16	6 5/16	7 3/32	10 1/4	18 11/16	2105
77000400	400	1600	11 7/32	12 19/32	13 25/32	11 13/16	44 5/32	4 1/8	7 3/32	7 7/8	11 13/16	19 7/8	2714
77000500	500	2000	11 7/8	13 3/8	15 15/32	13	47 27/32	4 5/16	7 15/32	8 21/32	12 19/32	21 21/32	3468
77000600	600	2400	12 5/16	13 25/32	16 17/32	14 3/16	50 19/32	4 23/32	8 1/4	9 27/32	13 3/8	22 27/32	4268
77000700	700	2800	12 23/32	14 3/16	17 23/32	14 1/16	52 5/32	4 15/16	8 21/32	11 1/32	14 35/32	23 3/8	5146
77000800	800	3200	13 1/4	14 31/32	19 11/16	16 7/32	58 1/4	5 1/2	9 7/16	11 13/16	15 3/4	26 3/16	6878

Tolerance: Machined parts ± 1/32 inch

14-06-2016