

Material : Alloy steel, Grade R3/R3S/R4/R4S
 Finish : Painted, special specifications on request
 Temperature range : -40°C up to +200°C, Polar Rated
 Standard certification : Certificate of Conformity
 3.1 material certificated EN 10204

Non-standard sizes or custom products available on request

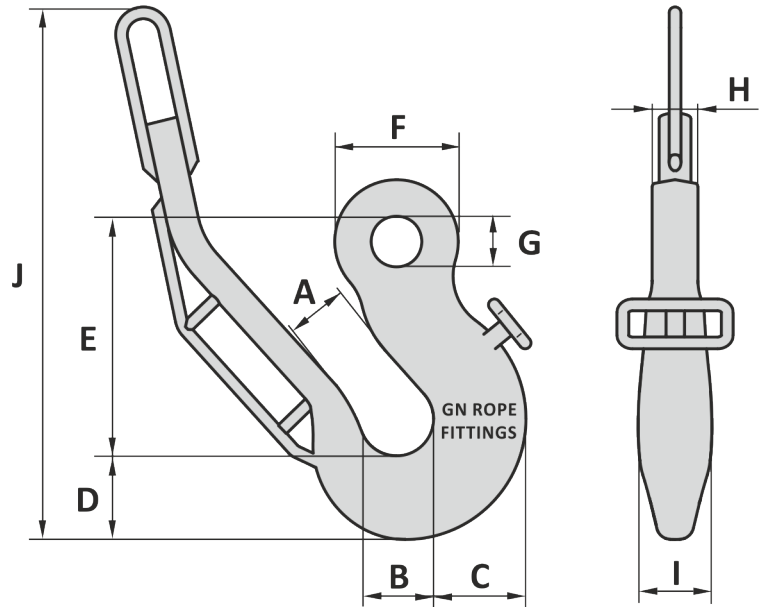

Art. No.	Hook No.	PL kN	MBL kN	A mm	B mm	C mm	D mm	E mm	F mm	G mm	H mm	I mm	J mm	Weight kg
75100040	40	7096	9001	162	200	250	225	645	334	135	131	200	1539	394
75100050	50	10700	13573	180	200	272	256	665	345	170	163	245	1443	481

Tolerance: ± 5%

Art. No.	Hook No.	PL kN	MBL kN	A inch	B inch	C inch	D inch	E inch	F inch	G inch	H inch	I inch	J inch	Weight lbs
75100040	40	7096	9001	6 3/8	7 7/8	9 7/32	8 7/8	25 1/2	13 1/32	5 1/16	5 1/32	7 7/8	60 19/32	869
75100050	50	10700	13573	7 1/32	7 7/8	10 23/32	10 1/16	26 3/16	13 19/32	6 1/16	6 1/32	9 21/32	56 13/16	1060

Tolerance: ± 5%

15-12-2021