

Material : Mild steel
 Finish : Galvanized
 Temperature range : -20°C up to +200°C
 Standard certification : Certificate of Conformity

Suitable for fibre rope
 Dimension E limited adjustable

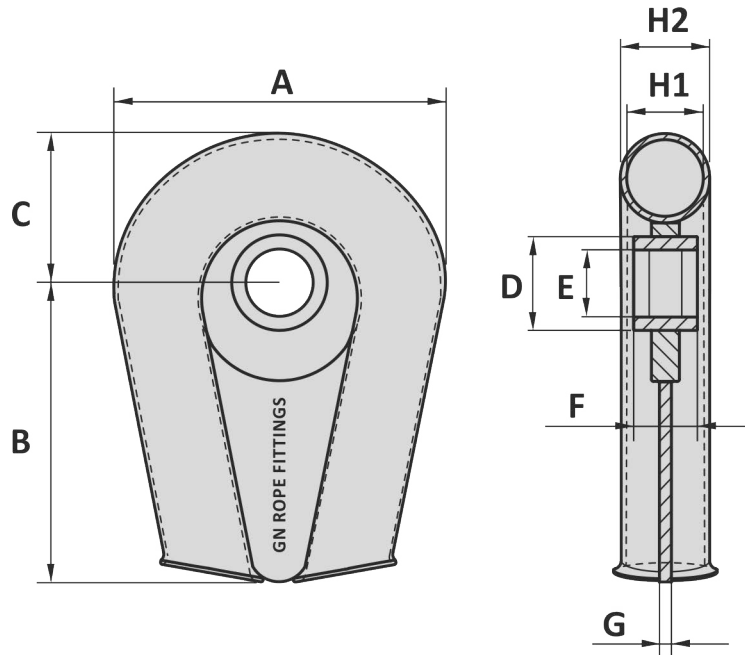

Art. No.	Rope size inch	A mm	B mm	C mm	D mm	E mm	F mm	G mm	H1 mm	H2 mm	Weight kg
18000600	6	254	200	126	-	60	-	30	64	70	7.8
18000800	8	318	250	158	-	80	-	40	82	89	15
18001001	10	419	360	210	190	132	105	15	107	114	28
18001200	12	521	416	250	194	144	130	20	132	140	46
18001500	15	625	539	282	194	144	150	25	159	168	74
18001800	18	734	640	336	219	169	175	30	183	194	126
18002100	21	829	780	374	219	169	200	30	207	219	176
18002400	24	924	915	421	273	201	225	40	232	245	272
18002700	27	1035	1060	477	273	201	250	50	260	273	400

Tolerance: ± 5%

Art. No.	Rope size inch	A inch	B inch	C inch	D inch	E inch	F inch	G inch	H1 inch	H2 inch	Weight lbs
18000600	6	10	7 7/8	4 3/32	-	2 3/8	-	1 3/16	2 1/2	2 3/4	17
18000800	8	12 1/2	9 27/32	6 7/32	-	3 5/32	-	1 9/16	3 7/32	3 1/2	33
18001001	10	16 1/2	14 3/16	8 1/4	7 15/32	5 3/16	4 1/8	19/32	4 7/32	4 1/2	62
18001200	12	20 1/2	16 3/8	9 23/32	7 5/8	5 11/16	5 1/8	25/32	5 3/16	5 1/2	101
18001500	15	24 3/8	21 3/32	11 3/32	7 5/8	5 11/16	5 29/32	1	6 1/4	6 5/8	163
18001800	18	28 29/32	25 3/16	13 7/32	8 5/8	6 21/32	6 3/8	1 3/16	7 3/16	7 5/8	278
18002100	21	32 5/8	30 23/32	14 23/32	8 5/8	6 21/32	7 3/8	1 3/16	8 5/32	8 3/8	388
18002400	24	36 3/8	36 1/32	16 1/16	10 3/4	7 29/32	8 3/8	1 1/16	9 1/8	9 23/32	600
18002700	27	40 3/4	41 1/4	18 25/32	10 3/4	7 29/32	9 23/32	1 31/32	10 1/4	10 3/4	882

Tolerance: ± 5%

01-07-2011